

TRUCK PARTS & INDUSTRIAL SUPPLIES

UTILITY TRAILER 2024

HEAT SHRINK ASSORTMENTS

Standard Heat Shrink Terminals
265 PC Assortment
 Gauges: 22-10
 Assortment Contains:
 Ring Terminals
 Spade Terminals
 Female Connectors
 Male Connectors
 Butt Connectors

CUSTOM ASSORTMENTS ARE ALSO AVAILABLE!

Clear Heat Shrink Terminals
285 PC Assortment
 Gauges: 22-10
 Assortment Contains:
 Ring Terminals
 Female Connectors
 Male Connectors
 Bullet Connectors
 Step Down Butt Connectors
 Butt Connectors



\$250.99^{ea}
 ASST3500



\$305.99^{ea}
 ASST3525

SAFETY CONES

PLAIN
 - Bounces back when crushed
 - Wide body for extra stability
 - PVC design for superior flexibility in heat or cold
 - Ridges on the inner cone allow for easy stacking and deployment
 - Superior fade resistance

18" CONE, PLAIN
\$8.79^{ea}
 LOGTC18TF

28" CONE, PLAIN
\$17.39^{ea}
 LOGTC28TF



REFLECTIVE COLLAR

- 28" tall
 - Orange 7lb wide body made with PVC for superior durability and flexibility
 - Exclusive 3M 3340 Series sheeting on reflective collars
 - One piece design

28" CONE, REFLECTIVE

\$30.69^{ea}
 AIRJB2RS70032CT3M64



4PK UTILITY STRAPS

FIND MORE OF THIS CATEGORY ON FLAP

RATCHET BUCKLE

Light-duty
 1" wide x 12" web

CAM BUCKLE



\$41.89^{ea}
 15531



\$32.99^{ea}
 15532

12V BATTERY

- 5 amps/hour
 - Sealed lead acid battery
 - For 1-2 axle trailers

\$22.49^{ea}
 REDUB1250



ELECTRIC BRAKE FORCE METER

- Designed for use on 7-way flat (spade) equipped vehicles
 - Displays real-time, brake controller output gain and timing
 - Quickly troubleshoots electrical circuits and ground condition
 - For use with aftermarket and integrated brake controllers
 - Microprocessor controlled simulates trailer brake loads
 - 25 foot cable allows one-man, in-cab testing of brake controller and all truck-side tow circuits



\$169.99^{ea}
 IPA9107A

MINI ASSORTMENTS

120 PC // ATC FUSES

- Contains 120 ATC fuses
 - From 5 to 30 amps
 - Convenient plastic bin



120 PC ATC FUSES
\$20.99^{ea}
 ASST3400MATM

150 PC // HAIR PINS

- Contains 150 hair pins
 - 6 different sizes
 - Convenient plastic bin



150 PC HAIR PINS
\$19.99^{ea}
 ASST3600M



Utility Trailer
 Parts & Supplies

FENDER MOUNT CLEARANCE LIGHT

- Functions as both forward facing amber clearance & rearward facing red marker
 - 3-year warranty



\$6.09^{ea}
 REDMC67ARB

HD FUSE HOLDER

- With protective cap
 - 3-30 amps
 - #12 lead wire
 - 32V



\$3.89^{ea}
 BUSHHG

STAIR STEP WHEEL CHOCK

- Zinc-plated eyebolt
 - 8" deep x 9-1/2" long x 5-3/4" high



\$26.99^{ea}
 GT2048D

ELECTRIC BRAKE ASSEMBLIES

10" X 2-1/4" BRAKES

- 4-bolt pattern
 - Fits 3.5K axles

\$45.99^{ea}
 LH: REDEB01100
 RH: REDEB01105



12" X 2" BRAKES

- 5-bolt pattern
 - Fits 6-7K axles

\$70.99^{ea}
 LH: REDEB01120
 RH: REDEB01125



BULLDOG JACKS

SWIVEL JACK

- 2,000 lb capacity
 - 15" lift
 - Side wind
 - 26.5" tall



\$149.99^{ea}
 RED158151

A-FRAME JACK

- 5,000 lb capacity
 - 15" lift
 - Top wind
 - 21.5" tall retracted

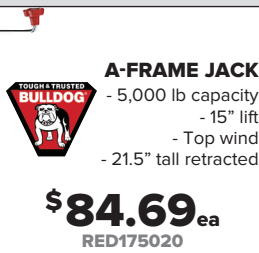

\$84.69^{ea}
 RED175020

PROTECTION FIRST CLASS

- Can be used to treat entire metal trailers or trailer frames to prevent rust and corrosion
 - Can also prevent rust and corrosion on your hitch ball and hitch mount
 - Will not harm paint, synthetic rubber, or plastic
 - Will not wash off / collect dust / dry out like oil, silicone and solvent based products
 - Protects electrical connections, battery terminals, switches, trailer lights & more



Thousands of Uses:

Mower Gates Mud Flaps
 Decks Cables Slide Pins
 Lift Chains & Much More!

\$9.19^{ea}
 BERKBPFCA12

LIGHT-DUTY CABLES

- For light-duty towing
 - Molded for moisture & corrosion resistance
 - Thermosealed plugs
 - Flexible from -87°F to 150°F



\$42.79^{ea}
 194710

\$49.29^{ea}
 196710

STA-DRY[®] 6- AND 4-WAY THERMOSEALED[™] PLUGS

- Molded for moisture & corrosion resistance
 - Flexible from -87°F to 150°F
 - Heavy duty jacketing for long life



AVAILABLE IN 6-WAY 6/16 GAUGE AND 4-WAY 4/16 GAUGE, 2' OR 4' BLUNT CUT STRAIGHT CABLES

LED LICENSE PLATE LIGHT

- Compact LED light illuminates your trailer's license plate
 - LEDs last 50x longer and are more efficient with less power output
 - Snap-on chrome-plated housing
 - Clear lens over white LEDs
 - Surface mount with foam gasket, hardware included
 - DOT approved when properly mounted

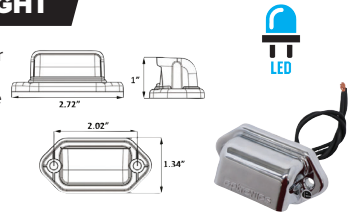

optronics

\$7.79^{ea}
 REDLPL31CB

LED TRAILER LIGHTING KIT

- Provides all legal lamps & reflective products for trailers <80" wide
 - Rugged design prevents corrosion
 - Solid state LED lamps offer greater resistance from damage due to vibration
 - Kit includes: 1 curbside lamp, 1 roadside lamp, wiring harness, license bracket, mounting hardware
 - Truck-Lite 2-year warranty



\$107.69^{ea}
 5050DK

EW0100 SERIES WHITE LED STRIP LIGHTING

CONVENIENT LIGHTING ANYWHERE

- Wire leads at both ends to allow multiple units to be connected
 - These strips are self-adhesive
 - Each strip can be cut every 3 LEDs
 - Easy to install with high-bond tape
 - Compact design allows them to be concealed easily in any location



LENGTH	ITEM NUMBER
12"	EW0116
24"	EW0117
36"	EW0111

IDEAL FOR ILLUMINATING WORK TRUCK COMPARTMENTS, TOOLBOXES, RACKING, SMALL OR LARGE INTERIOR COMPARTMENTS, ENCLOSED TRAILERS, BOX TRUCKS, AND MORE!

\$17.99^{ea}
 EW0116

\$29.99^{ea}
 EW0117

REPLACEMENT LED MINI BULBS

2PK 360° LED LIGHT BULBS

SIZE	ITEM NUMBER
1156	571.LD1156W18P2
1157	571.LD1157W18P2

\$21.59^{pk}

194 BULBS, 4 LEADS

BLUE, AMBER, OR RED
\$3.79^{ea}
 RDM1962(B/A/R)

WHITE
\$4.29^{ea}
 RDM1962W

12-LED BULBS
 YOUR CHOICE
\$6.69^{ea}

BULB SIZE	COLOR	ITEM NUMBER
1156	AMBER	RDM1960A
	RED	RDM1960R
1157	AMBER	RDM1961A
	RED	RDM1961R

BULB SIZE	COLOR	ITEM NUMBER
3156	AMBER	RDM1963A
	RED	RDM1963R
3157	AMBER	RDM1964A
	RED	RDM1964R

Introducing our new B2B ECOMMERCE SOLUTION
SHOP.BERGEYSTRUCK.COM

EASY. FAST. ACCURATE.

CREATE YOUR ACCOUNT TODAY!



AXLE COMPONENTS	pg. 2
ELECTRICAL	pg. 3
ESSENTIALS	pg. 3F
TOWING ACCESSORIES	pg. 4
CARGO CONTROL	pg. 4F



AXLE COMPONENTS

ELECTRIC BRAKE ASSEMBLIES

10" X 2-1/4" BRAKES

- Fits standard 3,500lb axle
- 4 Bolt pattern on mounting flange
- Complete assembly ready to bolt on and wire

- For use with a 10" inside diameter drum
- The shoes are 2-1/4" wide
- Mounting hardware included



YOUR CHOICE
\$45.99ea
LH: REDEB01100
RH: REDEB01105

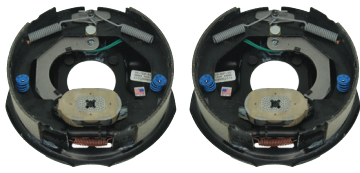

REPLACEMENT PARTS

MAGNET KIT, 3.5K **\$38.39**ea
REDBP01110

SHOE / LINING, 3.5K **\$52.79**ea
REDBP04095

12" X 2" BRAKES

- Fits standard 6,000lb - 7,000lb axle
- 5 Bolt pattern on mounting flange
- Complete assembly ready to bolt on and wire

- For use with a 12" inside diameter drum
- The shoes are 2" wide
- Mounting nuts included



YOUR CHOICE
\$70.99ea
LH: REDEB01120
RH: REDEB01125



REPLACEMENT PARTS

MAGNET KIT, 6-7K **\$49.59**ea
REDBP01180

SHOE / LINING, 6 & 7K **\$57.49**ea
REDBP04165

12-1/4" X 3-3/8" BRAKES

- Fits dexter 9,000lb - 10,000lb axles
- 7 Bolt pattern on mounting flange
- For use with a 12-1/4" inside diameter and 3-3/8" depth drum

- The shoes are 3-3/8" wide
- Complete assembly ready to install
- Self-adjusting



YOUR CHOICE
\$200.99ea
LH: REDEB01140
RH: REDEB01145



REPLACEMENT PARTS

MAGNET KIT, 9 & 10K GD **\$112.49**ea
REDBP01301

MAGNET CLIP, 4PK **\$6.99**ea
REDBP19005

HOW TO SELECT ELECTRIC BRAKE PARTS

HOW TO DETERMINE LEFT OR RIGHT BRAKE ASSEMBLY

- Position the brake with magnet at bottom
- Actuating arm will always curve from the Pivot pin to the magnet:
Toward the left for left hand brakes
Toward the right for right hand brakes

SELECTING ELECTRIC BRAKE PARTS

- Determine the size of your brake
 - Measure the diameter of the mounted shoe
 - Measure the width of the lining
- Determine the manufacturer
- Select part needed

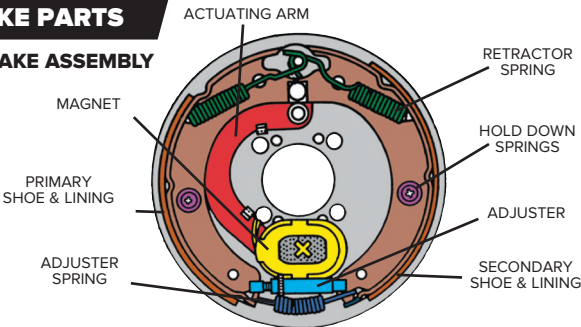

COMPLETE OIL CAP KITS

OTHER APPLICATIONS AVAILABLE

FITS	KIT CONTENTS	ITEM NUMBER
6k, 7k, 8k, & 9k 8-bolt Dexter Axles	21-35 Oil Cap, 10-45 O-Ring, 46-32 Plug	REDRG04230
10k & 12k Hayes / Alko Axles	92125 Oil Cap, 92127 O-Ring, 9103502 Plug, 92126 Plug	REDRG04250
Dexter 9k & 10k GD Axles (thru 07-09) with 2pc hub / drum	21-36 Oil Cap, 10-50 O-Ring, 46-32 Plug	REDRG04270
Dexter 9k & 10k GD Axles (after 07-09) with 1pc hub / drum	21-88 Oil Cap, 10-163 O-Ring, 46-32 Plug	REDRG04300



OIL CAP REPLACEMENT PARTS

DESCRIPTION	APPLICATION	ITEM NUMBER
Oil Cap Plug	21-35, 21-36, 21-37 Caps	RED4632
Oil Hub Plug	8k-15k Dexter Oil Hubs	RED4652
Oil Cap O-Ring	21-36 Oil Cap	RED1050

OIL CAP PLUG **\$2.29**ea
RED4632



OIL CAP O-RING **\$1.79**ea
RED1050

GREASE CAPS & CAP PLUGS

DESCRIPTION	QTY	O.D.	ITEM NUMBER
Drive-in, 2k & 3.5k Axles	2	1.986"	REDRG04020
Drive-in, E-Z Lube 2k & 3.5k Axles	2	1.986"	REDRG04040
Drive-in, 5.2k Axles w/6-bolt hubs	2	2.440"	REDRG04060
Drive-in, E-Z Lube 5.2k & 6k Axles w/6-bolt hubs	2	2.440"	REDRG04080
Drive-in, 5.2k, 6k, & 7k Axles w/old style "dome cap"	2	2.720"	REDRG04100
Drive-in, E-Z Lube 5.2k, 6k, & 7k 8-bolt Axles	2	2.720"	REDRG04120

DRIVE-IN, E-Z LUBE 2K & 3.5K AXLES
\$8.09pk
REDRG04040



DRIVE-IN, E-Z LUBE 5.2K, 6K, 7K, 8K AXLES
\$24.99pk
REDRG04120

SEALS

GREASE SEALS, 2-PACK

USE WITH	TYPE	I.D.	O.D.	ITEM NUMBER
E-Z Lube 5.2k, 6k, & 7k Axles	Double-Lip Seal	2.125"	3.376"	REDRG06090
E-Z Lube 3.5k Axles	Double-Lip Seal	1.719"	2.565"	REDRG06050
E-Z Lube 5.2k, 6k, & 7k Axles	Double-Lip Seal	2.250"	3.376"	REDRG06070
BT8 Spindles	Double-Lip Seal	1.250"	1.979"	REDRG06010

E-Z LUBE 3.5K AXLES
\$6.99pk
REDRG06050



E-Z LUBE 5.2K, 6K, 7K AXLES
\$7.09pk
REDRG06070



DEXTER 10K, 12K, 15K & HAYES AXLES
\$34.99pk
RED1056



DEXTER 9K, 10K GD AXLES
\$29.69pk
RED1051



OIL SEALS, INDIVIDUAL

USE WITH	TYPE	I.D.	O.D.	ITEM NUMBER
Dexter 9k, 10k GD Axles	Unitized Oil Seal	2.875"	3.880"	RED1051
Dexter 10k, 12k, 15k, & Hayes	Unitized Oil Seal	3.125"	4.500"	RED1056
Dexter 8k (& 9k 'til 10/89)	Unitized Oil Seal	2.250"	3.376"	RED1063
Hayes #99 Spindle	Unitized Oil Seal	2.750"	3.779"	RED91030

BEARING PROTECTORS

- Fits 1.980" 2k to 3.5k lb hubs



\$26.59ea
REDRG07040

DTT SERIES ALUMINUM DUMP TARP KITS AVAILABLE

- Built for simple dump body and dump trailer applications
- Kits feature aluminum mounting plates for a corrosion-resistant design
- Kits include a round, telescoping, extruded-aluminum tarp roller that is cranked with a detented crank handle for easy retracting and tightening
- Durable tarps feature brass grommets and heavy duty double-stitched and reinforced hems
- Solid vinyl tarps are rated to 400°F for covering asphalt
- Each tarp has a standard sewn-in rear pocket to fit an optional anti-sail retention blow (sold separately)
- Tarp kits can be ordered with tarps a la carte, or as a single part number with common tarp sizes
- All mounting hardware included
- All kits include: one 7 in. folding crank with detent, one round telescoping tarp roller, one 20 ft pull-rope, two rope tie down hooks, and two rubber tarp straps with s-hooks

Talk to your Outside Parts Sales representative for more information!



DESCRIPTION	MATERIAL	TARP LENGTH	TARP WIDTH	ITEM NUMBER
ALUMINUM TARP SYSTEM	SOLID VINYL	18.0'	7.0'	BUYDTT7018S
DUMP TARP KIT	PVC-COATED VINYL MESH	12.0'	5.0'	BUYDTT5012
DUMP TARP KIT	PVC-COATED VINYL MESH	11.0'	5.5'	BUYDTT5511
DUMP TARP KIT	PVC-COATED VINYL MESH	14.0'	6.0'	BUYDTT6014
DUMP TARP KIT	PVC-COATED VINYL MESH	15.0'	6.5'	BUYDTT6515
DUMP TARP KIT	PVC-COATED VINYL MESH	18.0'	6.5'	BUYDTT6518
DUMP TARP KIT	PVC-COATED VINYL MESH	12.0'	7.0'	BUYDTT7012
DUMP TARP KIT	PVC-COATED VINYL MESH	15.0'	7.0'	BUYDTT7015
DUMP TARP KIT	PVC-COATED VINYL MESH	18.0'	7.0'	BUYDTT7018
DUMP TARP KIT	PVC-COATED VINYL MESH	12.0'	7.5'	BUYDTT7512
DUMP TARP KIT	PVC-COATED VINYL MESH	15.0'	7.5'	BUYDTT7515
DUMP TARP KIT	PVC-COATED VINYL MESH	18.0'	7.5'	BUYDTT7518
DUMP TARP KIT	PVC-COATED VINYL MESH	20.0'	7.5'	BUYDTT7520
DUMP TARP KIT	PVC-COATED VINYL MESH	18.0'	8.0'	BUYDTT8018
DUMP TARP KIT	PVC-COATED VINYL MESH	22.0'	8.0'	BUYDTT8022

ELECTRONIC BRAKE CONTROLS

TA1000 BRAKE CONTROL

- For 1-2 axles
- Full brake actuation in ~2.5 seconds
- Manual override
- 2-color LED indicator light
- Mounts in any position
- 5-year limited warranty



\$76.99ea
REDTA1000

TA1200 BRAKE CONTROL

- For 1-3 axles
- Digital display shows voltage applied to brakes and trailer connection
- Full brake actuation in ~2.5 seconds
- Manual override
- Mounts in any position
- Limited lifetime warranty



\$109.89ea
REDTA1200

VOYAGER BRAKE CONTROL

- For 1-4 axles
- Manual override
- LED indicator light
- Mounts under dash
- 5-year limited warranty



\$160.19ea
RED9030A

COMPLETE HUB AND DRUM ASSEMBLIES

Complete hub assembly includes: hub and studs, outer bearings, inner bearings, outer race, inner race, grease cap, grease seal, and 5 wheel nuts.

- 1,750 Lbs capacity
- Bolt pattern: 5 on 4.5"
- Fits most 3.5k lb axles, including Dexter



\$57.99ea
REDH84545BX

Complete hub assembly includes: hub and studs, outer bearings, inner bearings, outer race, inner race, grease cap, grease seal, and 8 wheel nuts.

- 3,500 Lbs capacity
- Bolt pattern: 8 on 6.5"
- 5.2k lb and 7l lb axles that require a 2.25" I.D. grease seal



\$149.99ea
REDHD42866BX



Complete hub assembly includes: hub and studs, outer bearings, inner bearings, outer race, inner race, grease cap, grease seal, and 5 wheel nuts.

- 1,750 Lbs capacity
- Bolt pattern: 5 on 4.5"
- Fits most 3.5k lb axles, including Dexter



\$99.89ea
REDHD84546BX

Complete hub assembly includes: hub and studs, outer bearings, inner bearings, outer race, inner race, grease cap, grease seal, and 6 wheel nuts.

- 3,000 lbs capacity
- Bolt pattern: 6 on 5.5"
- 5.2k lb and 6k lb axles that require a 2.125" Or 2.25" I.D. grease seal

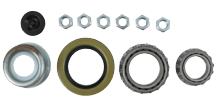

\$143.39ea
REDHD42656BX



WHEEL BEARING KITS

OTHER APPLICATIONS AVAILABLE

OUTER BEARING	INNER BEARING	SEAL I.D.	ITEM NUMBER
L44643	L44643	1.250"	REDBK1100
L44649	L44649	1.500"	REDBK1150
L44649	L68149	1.719"	REDBK2100
15123	25580	2.250"	REDBK3100
14125	25580	2.250"	REDBK3200
14125	25580	2.125"	REDBK3210
LM67048	25580	2.125"	REDBK3310



L44649, L68149, 1.719"
\$14.29ea
REDBK2100

14125, 25580, 2.250"
\$29.19ea
REDBK3200

ONE KIT PER WHEEL REQUIRED

DRIVE-IN WHEEL STUDS

A	B	C	D	E	QTY	ITEM NUMBER
1/2"	1-13/16"	0.62"	0.73"	0.61"	4	REDRG03040
5/8"	3-1/8"	0.31"	1.39"	0.69"	4	REDRG03120

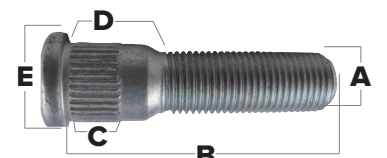

\$16.39pk
REDRG03040



\$46.99pk
REDRG03120



"ENGAGER" BREAKAWAY KITS

- Activates trailer brakes upon separation from vehicle
- For vehicles with 1-2 axles
- LED charge indicator
- Built-in charger keeps battery fully charged
- Battery uses 5 amps/hour
- Mounting hardware included



\$49.59 ea
REDBA10150

WITH FLIP TOP

- Activates trailer brakes upon separation from vehicle
- For vehicles with 1-2 axles
- LED charge indicator
- Built-in charger keeps battery fully charged
- Battery uses 5 amps/hour
- Mounting hardware included



\$51.49 ea
REDBA10250

TAILGATE LATCH ASSEMBLIES

- Ideal for sealing dump trailer tailgates against body
- Keeps mulch, dirt, loose stone, or any messy material inside the trailer
- Help prevent unintentional opening of the tailgate



\$54.99 ea
BUYTGL3410

\$50.49 ea
BUYTGL3410ST

BREAKAWAY SWITCH

- Nylon case
- 48" cable & leads
- Includes metal bracket



\$13.39 ea
REDBA02010

BREAKAWAY SWITCH

- Can weld or bolt on
- Pin and cable included
- Long lead wires



\$21.19 ea
RED2010

REPLACEMENT PULL PIN/CABLE

- Nylon pull pin & cable
- Replacement for break-away switch 2010



\$10.29 ea
RED2010A

PARALLEL BONDED WIRE

- 4-CONDUCTOR
- White, brown, yellow, green
- General purpose thermoplastic wire
- Clear, PVC jacket insulation
- Ideal for RV, boat, and utility trailers



\$1.39 ft
825514

TRAILER CABLE

- Resists temperatures from -40°F to 221°F
- Vinyl outer jacket provides weather and abrasive protection
- Designed for 12V and 24V systems
- Made in North America



\$1.59 ft
825602

6-CONDUCTOR

- Yellow, green, brown, white, red, & black



\$1.79 ft
825604

7-CONDUCTOR

- Yellow, green, brown, white, red, black, & blue



\$2.39 ft
825611

14 GA. THERMO PLASTIC WIRE

- Spools of 100'
- Primary wire is single conductor based PVC jacketed wire
- PVC insulation resists heat up to 185°F (85°C) and provides protection from weather conditions and abrasives
- Meets SAE code J1128 specifications



\$16.99 ea
YOUR CHOICE

CONNECTOR ASSEMBLIES

- 12" LEAD
- 4-pole complete assembly
- 18-gauge wire
- 12 volts, 15 amps
- Color coded wires



\$5.09 ea
POL12403P

48" LEAD ON CAR SIDE

- 12" LEAD ON TRAILER SIDE
- 4-pole complete assembly
- 18-gauge wire
- 12 volts, 15 amps
- Color coded wires



\$6.99 ea
POL12404P

CONNECTOR ADAPTORS

- 7-POLE TO 4-POLE
- Allows vehicle to tow campers or boat trailers without electric brakes
- Protection from sand, dirt, and moisture
- Eliminates makeshift jumpers



\$6.49 ea
POL12761P

7-POLE TO 6-POLE

- Converts 7-way blade connector to 6-way round connector plug
- Auxiliary pin in the center of the 6-way



\$8.59 ea
POL12729P

FEDERAL LIGHTING REQUIREMENTS

- | | |
|--|------------------------------------|
| 1 - TAIL LAMPS | 6 - REAR CLEARANCE LAMPS |
| 2 - LICENSE PLATE LAMP(S) | 7 - REAR IDENTIFICATION (ID) LAMPS |
| 3 - REAR SIDE MARKER LAMPS | 8 - FRONT CLEARANCE LAMPS |
| 4A - FRONT SIDE MARKER LAMPS | 9 - REAR UPPER BODY MARKINGS |
| 4B - FRONT SIDE REFLEX REFLECTORS | 10 - BUMPER BAR MARKING |
| 5A - INTERMEDIATE SIDE MARKER LAMPS | 11 - REAR LOWER BODY MARKING |
| 5B - INTERMEDIATE SIDE REFLEX REFLECTORS | 12 - SIDE MARKING |

THIS IS AN ABBREVIATED VERSION;
FOR FULL DETAILS PLEASE VISIT
WWW.NHTSA.DOT.GOV

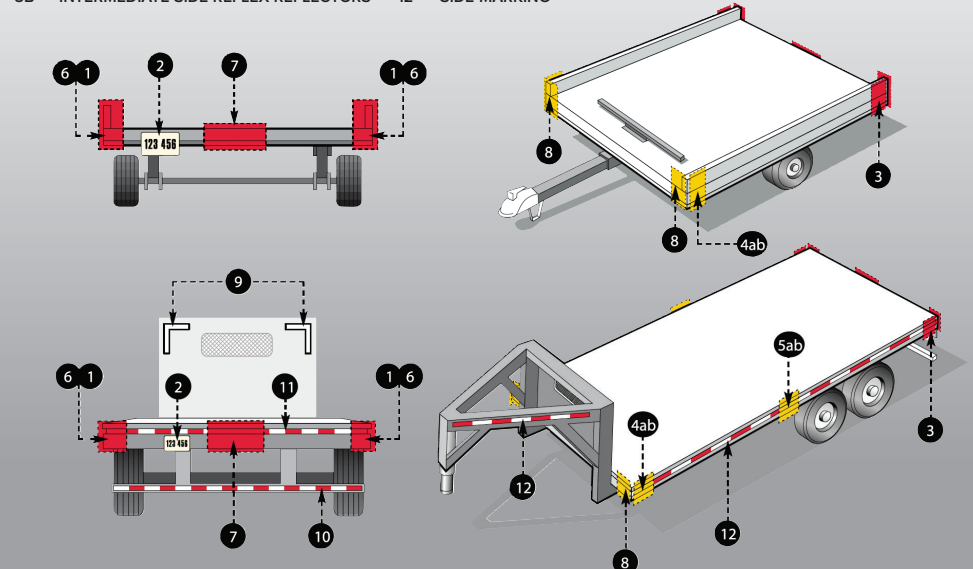

REPLACEMENT LED S/T/T LAMPS

CURBSIDE

- Serves 6 functions: stop, turn, tail, rear reflex, side marker, & side reflex
- For trailers less than 80" wide
- Submersible
- Corrosion resistant
- 2" stud centers



\$41.99 ea
5055D

ROADSIDE

- Serves 7 functions: stop, turn, tail, rear clearance, rear reflex, side marker, side reflex, & license plate illuminator
- For trailers less than 80" wide
- Submersible
- Corrosion resistant
- 2" stud centers



\$41.99 ea
5056D

REPLACEMENT INCANDESCENT S/T/T LAMPS

CURBSIDE

- Serves 6 functions: stop, turn, tail, rear reflex, side marker, & side reflex
- For trailers <80" wide
- No plug required, simply insert wires
- Corrosion resistant
- 2" stud centers

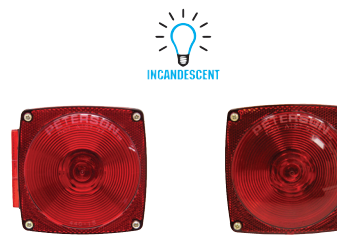

\$3.99 ea
RED440

ROADSIDE

- Serves 7 functions: stop, turn, tail, rear reflex, side marker, side reflex, & license plate illuminator
- For trailers less than 80" wide
- No plug required, simply insert wires
- Corrosion resistant
- 2" stud centers

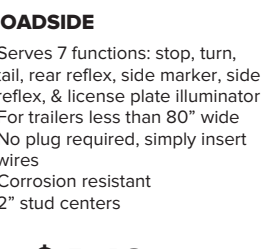

\$4.19 ea
RED440L

7-POLE HEAVY DUTY STYLE SOCKET

- High-impact nylon solves corrosion problems and eliminates rust when mated with special interlocking sealed connector
- Prevents sand and dirt from impairing closure
- Socket lid has a drain slot
- Tin-plated copper alloy terminal pins
- Fits Ford style and new universal pollak 12-711U mounting bracket
- Includes mounting hardware



\$12.99 ea
POL11893P

7-POLE CONNECTORS

- Eliminates rusting and difficulty in plug removal
- Dual grips for ease of plug removal
- Vinyl inserts to keep out dirt and moisture
- Socket has non-corroding, shock-resistant interior design that eliminates shorting out
- Socket is color coded to RV1 standards
- Safety latch on socket ensures that the connector is plugged in the socket



TRAILER-END, ONLY PLUG
\$7.79 ea
POL12706P



CAR-END, ONLY PLUG
\$5.49 ea
POL12707EP

6-POLE CONNECTORS

- PLUG, NO CABLEGUARD
- Brass terminal pins accept up to 12 gauge wires
- Two 1/4" mounting holes
- Mounts through 1-3/8" hole



\$7.69 ea
POL11604P

PLUG, WITH CABLEGUARD

- Brass terminal pins accept up to 12 gauge wires
- Two 1/4" mounting holes
- Mounts through 1-3/8" hole



\$9.99 ea
POL11605P

SOCKET, CONCEALED TERMINALS

- Brass terminal pins accept up to 12 gauge wires
- Two 1/4" mounting holes
- Mounts through 1-3/8" hole
- Plated steel cable guard prevents cable chafing



\$11.99 ea
POL11609P

4-POLE CONNECTORS

- HD PLUG, NO CABLEGUARD
- Extended exterior and socket conceals terminals
- Unique cable clamp prevents chafing
- Dust and water resistant



\$7.29 ea
POL11402P

HD PLUG, WITH CABLEGUARD

- Extended exterior and socket conceals terminals
- Unique cable clamp prevents chafing
- Dust and water resistant



\$7.49 ea
POL11403EP

HD CONNECTOR SOCKET

- Extended exterior and socket conceals terminals
- Unique cable clamp prevents chafing
- Dust and water resistant



\$9.99 ea
POL11404EP

RIDE-RITE AIR HELPER SPRINGS

- Haul with comfort, confidence and control
- Firestone Air Spring Systems are designed to maximize safe load carrying capacity, stability and overall ride quality
- Most kits are no-drill systems, easily installing in 1-2 hours
- Supports up to 5,000 lbs per set (do not exceed vehicle's recommended Gross Vehicle Weight Rating/GVWR)
- Designed and assembled in the USA



MODEL	MODEL NOTES	YEAR RANGE	ITEM NUMBER
SILVERADO / SIERRA 1500	ALL	1988 - 1998	FIW217602025
SILVERADO / SIERRA 1500	ALL	1999 - 2007	FIW217602320
SILVERADO / SIERRA 1500	ALL	2001 - 2010	FIW217602250
SILVERADO / SIERRA 1500	ALL	2007 - 2017	FIW217602430
SILVERADO / SIERRA 2500	ALL	1988 - 1998	FIW217602025
SILVERADO / SIERRA 2500	ALL	1999 - 2005	FIW217602190
SILVERADO / SIERRA 2500	ALL	2001 - 2010	FIW217602250
SILVERADO / SIERRA 2500	ALL	2011 - 2019	FIW217602613
SILVERADO / SIERRA 3500	ALL	1988 - 2000	FIW217602025
SILVERADO / SIERRA 3500	ALL	2001 - 2010	FIW217602250
SILVERADO / SIERRA 3500	ALL	2011 - 2019	FIW217602613
FULL SIZE PICKUPS			
RAM 1500	ALL	1994 - 2001	FIW217602071
RAM 1500	ALL	2002 - 2008	FIW217602286
RAM 1500	ALL	2009 - 2018	FIW217604185
RAM 2500	ALL	1994 - 2002	FIW217602071
RAM 2500	ALL	2003 - 2012	FIW217602299
RAM 2500	ALL	2013	FIW217602560
RAM 2500	4X4	2014 - 2019	FIW217602580
RAM 3500	ALL	1994 - 2002	FIW217602071
RAM 3500	ALL	2003 - 2012	FIW217602299
RAM 3500	4X4 W/O FACTORY AIR ASSIST	2013 - 2019	FIW217602560
RAM 3500	CAB & CHASSIS	2007 - 2019	FIW217602478
F-150	ALL	1968 - 1996	FIW217602071
F-150	ALL	1997 - 2004	FIW217602320
F-150	ALL	2004 - 2008	FIW217602350
F-150	NOT THE FX2 OR RAPTOR	2009 - 2014	FIW217602525
F-150	W/B&W TURNOVERBALL	2009 - 2014	FIW217602542
F-150	ALL	2015 - 2019	FIW217602582
F-250	ALL	1969 - 2004	FIW217602071
F-250	W/IN-BED HITCH	1999 - 2004	FIW217602550
F-250	ALL	2005 - 2007	FIW217602400
F-250	ALL	2008 - 2010	FIW217602550
F-250	GAS AND DIESEL	2011 - 2016	FIW217602597
F-250	GAS AND DIESEL	2017 - 2019	FIW217602600
F-350	ALL	1963 - 1998	FIW217602071
F-350	ALL	1999 - 2004	FIW217602550
F-350	4X4 ONLY	2005 - 2007	FIW217602400
F-350	ALL	2008 - 2010	FIW217602550
F-350	GAS AND DIESEL	2011 - 2016	FIW217602597
F-350	GAS AND DIESEL	2017 - 2019	FIW217602600
TOYOTA TUNDRA	ALL	2007 - 2019	FIW217602445

D-RINGS

D-RINGS ARE NOT APPROVED FOR OVERHEAD USE

DESCRIPTION	DIAMETER	W.L.L.	STRENGTH	ITEM NUMBER
LIGHT-DUTY SURFACE MOUNT ROPE RING	1/4"	400 LBS	1,200 LBS	BUYB23
HEAVY-DUTY ROPE RING	3/8"	2,000 LBS	6,000 LBS	BUYB28F
FORGED D-RING W/ 2-HOLE BRACKET	1/2"	4,080 LBS	11,781 LBS	BUYB38
FORGED D-RING W/ WELD-ON BRACKET	1/2"	4,080 LBS	11,781 LBS	BUYB38W
FORGED D-RING W/ MOUNTING BRACKET	5/8"	6,130 LBS	18,390 LBS	BUYB40
FORGED D-RING W/ MOUNTING BRACKET	3/4"	9,120 LBS	26,500 LBS	BUYB46
FORGED D-RING W/ MOUNTING BRACKET	1"	15,586 LBS	46,760 LBS	BUYB48



ROPE RINGS

- 1/4" diameter
- W.L.L. 800 lbs
- Ultimate breaking strength: 2,400 lbs
- Do not use for lifting



\$2.09 ea
BUYB20

ROPE RINGS

- 3/8" diameter
- W.L.L. 2,000 lbs
- Ultimate breaking strength: 6,000 lbs
- Do not use for lifting



\$4.29 ea
BUYB32F

LOCK PINS

SIZE	ITEM NUMBER
1/4" x 1-13/16"	BUY66050
1/4" x 2-1/2"	BEE2807
1/4" x 3"	BUY66066
1/4" x 3-5/8"	BUY66070
3/8" x 2-1/4"	BEE2804
5/16" x 2-3/4"	BEE2802

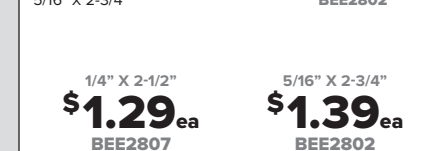

\$1.29 ea
BEE2807

\$1.39 ea
BEE2802



\$0.79 ea
BEE6302

SAFETY HOOK

- 3/8" diameter
- 3/16" chain size
- Min. break strength: 2,000 lbs





18" SOFT LOOP

- Can be used to loop or create a slip knot and attach to s-hooks
- Working load limit: 1,000 lbs

\$8.39^{ea}
15471

TIRE NET

- Ratchet handle
- 2" narrow wire hooks
- Fits 13" to 20" tires
- Working load limit: 1,670 lbs

\$45.29^{ea}
TN076

RECREATIONAL RATCHET STRAP ASSEMBLIES

SIZE / STRAP ENDS	WORKING LOAD	ITEM NUMBER
1" x 9' W/VINYL S-HOOKS	400 LBS	760987PK
1" x 16' W/WIRE HOOKS & D-RINGS	835 LBS	71168145PK

\$11.39^{ea} 760987PK
\$17.99^{ea} 71168145PK

AUTO RATCHET TIE DOWN

- 2" webbing x 7" long
- Ratchet handle and 2" snap hooks
- Working load limit: 3,335 lbs

\$39.99^{ea}
156611

AXLE STRAP

- Axle strap with delta rings
- 2" wide x 2' long
- Minimum breaking strength: 2,000 lbs

\$19.39^{ea}
RED802AS

TRACK FITTING

- Series E or A
- With 1" D-ring
- W.L.L. 2,000 lbs

\$8.99^{ea}
FEB2641

ROPE TIE-OFF

- 2" webbing x 6" long
- W.L.L. 1,000 lbs

\$5.59^{ea}
660001

INTERIOR VAN PRODUCTS

10' E-SERIES TRACK

- 12-gauge high strength steel
- Gray powder coat

\$47.99^{ea}
43002

RATCHET STRAPS

DESCRIPTION	TYPE	WORKING LOAD	ITEM NUMBER
2" x 12' E-TRACK	CAM	835 LBS	651201BT
2" x 12' E-TRACK	RATCHET	1,000 LBS	641201BT
2" x 16' E-TRACK	RATCHET	1,000 LBS	641601BT

\$12.39^{ea}
641201BT

CHAIN

5/16" X 20' LONG

- Grade 70 pre-cut chain
- With grab hooks
- Breaking strength: 18,800 lbs
- W.L.L.: 4,700 lbs

\$53.99^{ea}
1003420BX

3/8" X 20' LONG

- Grade 70 pre-cut chain
- With grab hooks
- Breaking strength: 26,400 lbs
- W.L.L.: 6,600 lbs

\$66.99^{ea}
1003820BX

RATCHET / LEVER BINDERS

PEERLESS

QUIKBINDER PLUS

The Quikbinder® is a ratchet binder like nothing you've seen before. Its unique vinyl coated barrel on the free spin gear gives you a firm grip so you can take up as much slack on the chain as possible before ratcheting into final position. Quickly switch from extension, to take-up, or use the free spin mode for fast adjustment in either direction. Its patented folding handle lets you quickly secure the load, and then tuck the handle out of the way from any potential snag. When the load is secure, be sure to use the Quikbinder® Lock to ensure the safety of your cargo and protect against tampering.

SIZE	WORKING LOAD	ITEM NUMBER
SIZE: 5/16" - 3/8" WLL: 7,100 LBS		\$58.99^{ea} SCCH51250658
SIZE: 3/8" - 1/2" WLL: 12,000 LBS		\$69.99^{ea} SCCH51250858
SIZE: 1/2" - 5/8" WLL: 18,100 LBS		\$121.49^{ea} SCCH51250958

SMARTBAR™

- Adjusts continuously from 48" to 108"
- Securement range from small truck bed to full high cube trailer width

PEERLESS

\$57.99^{ea}
SCCCC5010

EZ GATE™ TAILGATE ASSIST

Buyers Products EZ Gate™ Tailgate Assist reduces physical strain when lifting and lowering heavy trailer tailgates by up to 90%. The spring-loaded mechanism mounts to your trailer's side rail and attaches to the tailgate, taking most of the gate's weight off the user's hands.

- Reduces lifting by 90% when raising or lowering tailgates on utility trailers
- One kit is strong enough to work on tailgates up to 180lbs
- Mounting hardware included for installation
- No-rattle spring insert for quieter application when in use
- Works on most open utility trailers with a side rail height of 10" - 24"
- Constructed from heavy duty steel and black powder coat finish

\$171.99^{ea}
BUY5201000

PINTLE HOOKS

- Strong, drop-forged steel construction for maximum durability with a corrosion-resistant powder coating
- Spring-loaded pintle hook lock arm provides a secure hold on 2" to 2" I.D. lunette eyes

CAPACITY	M.V.L.	M.G.T.W.	ITEM NUMBER
10 TON	4,000 LBS	20,000 LBS	BUYPH10
20 TON	8,000 LBS	40,000 LBS	BUYPH20

\$66.99^{ea} BUYPH10
\$92.99^{ea} BUYPH20

PINTLE MOUNTS

- Versatile mounting plates to be used with a wide range of pintle hooks
- Strong and durable continuous weld construction
- Corrosion-resistant powder-coated finish

SHANK SIZE	PLATE SIZE	M.G.T.W.	ITEM NUMBER
2" x 12.25"	5" x 12.5"	10,000 LBS	BUYPM812
2" x 9"	5" x 7.38"	14,000 LBS	BUYPM87
2.5" x 12"	5" x 6.13"	16,000 LBS	BUYPM25612

\$52.99^{ea} BUYPM87
\$60.99^{ea} BUYPM25612

COMBINATION HITCHES

- Handles multiple towing needs with its interchangeable design
- Ideal for a wide range of light to medium duty trucks with a MGTW of 16,000 lbs
- Tough, interchangeable forged steel hitch ball
- Durable and long-lasting drop-forged construction with a corrosion-resistant powder-coated finish

BALL SIZE	M.V.L.	M.G.T.W.	WEIGHS	ITEM NUMBER
2"	3,000 LBS	16,000 LBS	13 LBS	BUYBH82000
2-5/16"	3,000 LBS	16,000 LBS	13.5 LBS	BUYBH82516

\$103.49^{ea} BUYBH82000
\$105.99^{ea} BUYBH82516

TRI-BALL HITCH

- 3 towing ball sizes on one solid shank
- 1-7/8", 2", 2-5/16"
- Tubular shank for 2" receiver tubes
- Black powder coated finish
- 5/8" hitch-pin hole

\$49.59^{ea}
BUY1802202

TRI-BALL HITCH WITH PINTLE HOOK

- 3 towing ball sizes: 1-7/8", 2", 2-5/16"
- For 2" receiver tubes
- Black powder coated tube finish
- Chrome ball finish

\$145.69^{ea}
BUY1802279

BALL MOUNTS

2" SHANK BALL MOUNT

- 8" long
- 2" max drop, 3/4" rise
- M.V.L. 600 lbs
- M.G.T.W. 6,000 lbs

\$21.89^{ea}
BUY1803005

2" SHANK BALL MOUNT, HEAVY-DUTY

- 7.63" long
- 2" max drop, 3/4" rise
- M.V.L. 2,000 lbs
- M.G.T.W. 20,000 lbs

\$39.99^{ea}
BUY1803050

HITCH BALLS

BALL SIZE	FINISH	SHANK DIA.	M.G.T.W.	ITEM NUMBER
1-7/8"	CHROME	3/4"	3,500 LBS	BUY1802015
2-5/16"	ZINC	1"	6,000 LBS	BUY1802162
2"	CHROME	1"	10,000 LBS	BUY1802007
2-5/16"	CHROME	1"	10,000 LBS	BUY1802027
2-5/16"	CHROME	1-1/4"	10,000 LBS	BUY1802025

\$16.99^{ea} BUY1802007
\$21.39^{ea} BUY1802025

A-FRAME JACK

- 5,000 lb capacity
- 15" lift
- Top wind
- 21.5" tall retracted

\$84.69^{ea}
RED175020

SNAP RING JACK

- 2,000 lb capacity
- Weld-on bracket
- Top wind
- Sand foot
- 18.5" tall retracted

\$90.99^{ea}
RED151401

PIPE MOUNT SWIVEL JACKS

CAPACITY	LIFT	HEIGHT	WIND	ITEM NUMBER
2,000 LBS	10"	17"	SIDE	RED158109
2,000 LBS	15"	27.75"	TOP	RED158452
2,000 LBS	15"	26.5"	SIDE	RED158151

\$149.99^{ea} RED158151
\$123.19^{ea} RED158452

DROPLEG JACKS

CAPACITY	STATIC LOAD	LIFT	DROPLEG TRAVEL	ITEM NUMBER
12,000 LBS	12,000 LBS	13.5"	12"	RED48000SL
12,500 LBS	20,000 LBS	12"	14"	REDDUALPINSL

\$410.99^{ea} RED48000SL
\$410.99^{ea} REDDUALPINSL

FOOT PLATE & PIN

- For 2,500 lb to 5,000 lb A-Frame jacks

\$13.99^{ea}
RED140070

FOLDING FOOT STEP

- Can also be used as a grab step

\$27.99^{ea}
BUYB27975S

PINTLE EYE

I.D.	THICKNESS	CAPACITY
3"	1.58"	20,000 LBS

\$60.99^{ea}
RED16137

GRADE 70 SLIP HOOKS WITH LATCH

- Zinc-plated, forged alloy steel
- Reliably secure your heavy-duty cargo
- 5/16" hook has a special latch to prevent chain from slipping out of the hook
- 3/8" hook is designed with a wider throat to make it easier to grab hold of bulky chains

SLIP HOOK	WORKING LOAD LIMIT	ITEM NUMBER
5/16" SLIP HOOK	4,700 LBS	10116312
3/8" SLIP HOOK	6,600 LBS	10116375

\$8.29^{ea} 10116312
\$9.49^{ea} 10116375

SAFETY CHAINS

Trailer chains provide peace of mind by securing the trailer to the tow vehicle.

DO NOT USE FOR OVERHEAD LIFTING

DESCRIPTION	CHAIN DIAMETER	LENGTH	CLASS	MIN. BREAKING STRENGTH	ITEM NUMBER
CLEVIS SLIP HOOK W/LATCH	5/16"	36"	IV	7,600 LBS	REDCS51636G30
SLIP HOOK W/LATCH	5/16"	36"	--	11,700 LBS	REDCS51636G43
CLEVIS SLIP HOOK W/LATCH	3/8"	35"	--	16,200 LBS	REDCS3835

\$24.69^{ea} REDCS51636G30
\$32.99^{ea} REDCS51636G43

RUBBER BUMPERS

2.5" ROUND

- Used as cushion for ramps & lift gates
- 1" tall x 2.5" round

\$2.49^{ea}
BUYB1001

D-BUMPER

- 6" center to center of holes
- 2 holes
- 10" long

\$9.88^{ea}
BUYD210

Bergey's

PA/MD PARTS STORES

- Allentown
- Bedford
- Clearfield
- Johnstown
- Hagerstown, MD
- Milton
- Nottingham
- Telford
- York

PA TRUCK CENTERS

- Camp Hill
- Carlisle
- Conshohocken
- Ephrata
- Harrisburg
- Kennett Square
- Lebanon
- Milton I80
- Reading
- Souderton
- Wrightsville

NJ TRUCK CENTERS

- Pennsauken
- Trenton
- Vineland

DE TRUCK CENTERS

- New Castle

MD TRUCK CENTERS

- Delmar

See QR code for commercial location details.